

3 KADEMELİ ÖNDEN TERAZİ MAFSALLI (TİP C)

Balance articulated at front 3 stages (Type C)

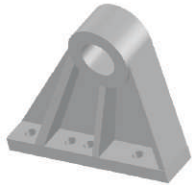
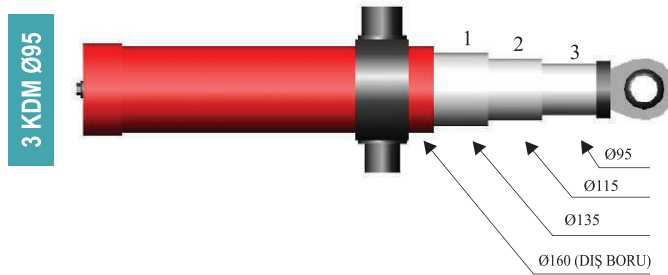
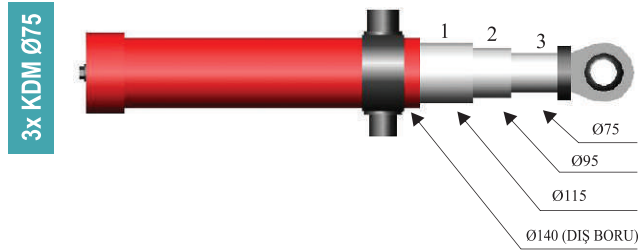
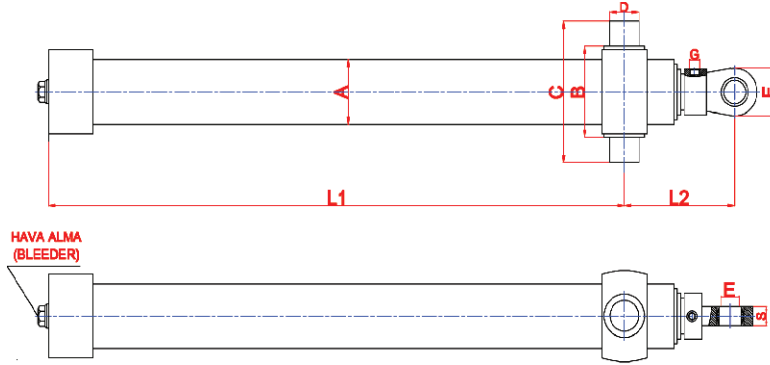

TİP (TYPE)	ØA	B	C	ØD	ØE	F	G	L1	L2	S	H STROK	KG	MAX.ÇALIŞMA BASINCI (BAR)	YAĞ HACMI (LT.)
HDC 3x3000xØ75	140	174	274	55	50	105	R 3/4"	1150	180	40	3000	127	170	34
HDC 3x3000xØ95	165	205	325	65	50	110	R 3/4"	1150	180	40	3000	161	170	49
HDC 3x3500xØ75	140	174	274	55	50	105	R 3/4"	1295	180	40	3320	145	170	41
HDC 3x3500xØ95	165	205	325	65	50	110	R 3/4"	1295	180	40	3320	180	170	58
HDC 3x4000xØ75	140	174	274	55	50	105	R 3/4"	1525	180	40	4000	154	170	48
HDC 3x4000xØ95	165	205	325	65	50	110	R 3/4"	1525	180	40	4000	192	170	67

Kapalı boy ve strok ölçüleri talebe göre değiştirilebilir.
Length and stroke dimensions are subject to change according to demand closed



4 KADEMELİ ÖNDEN TERAZİ MAFSALLI (TİP C)

Balance articulated at front 4 stages (Type C)

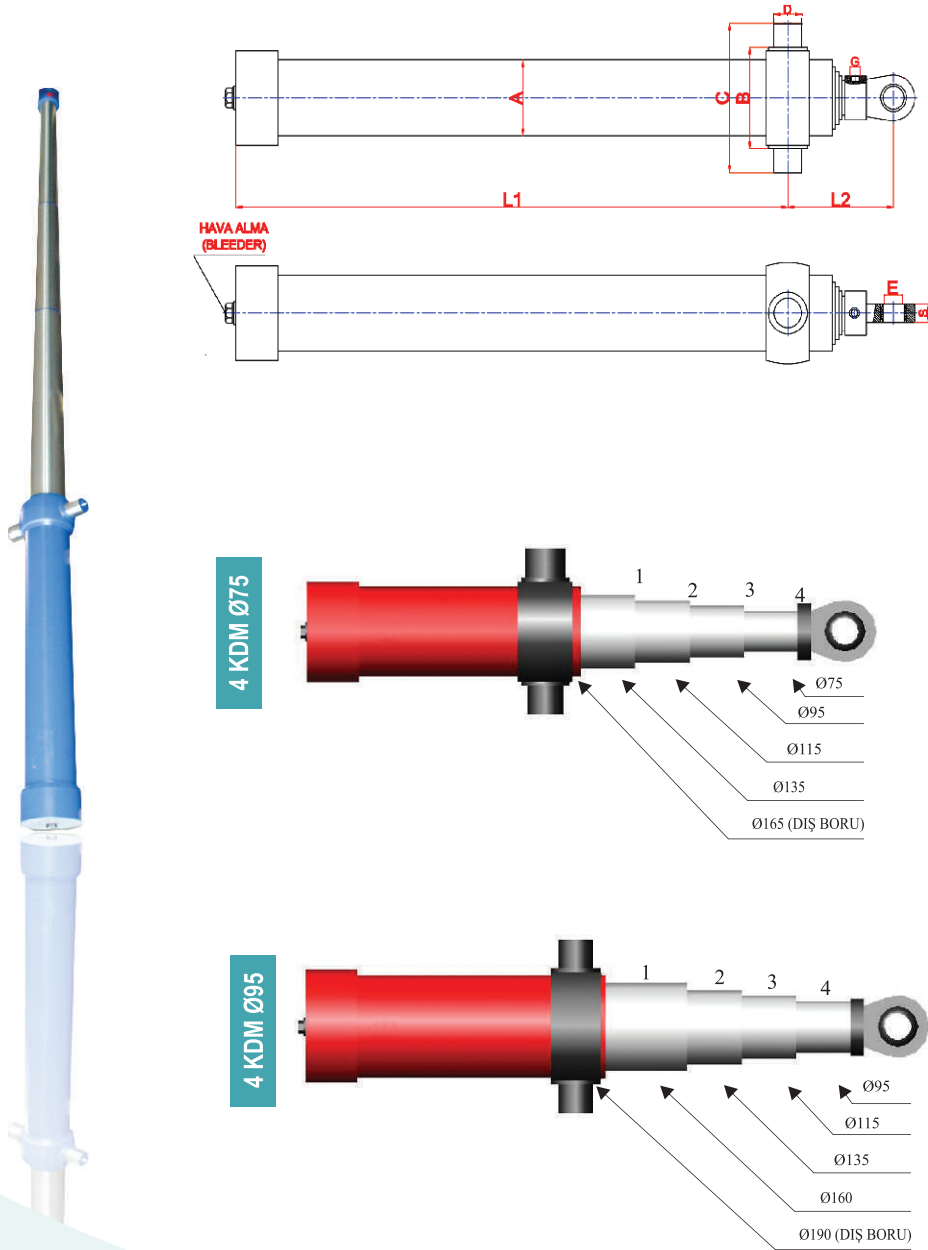

TİP (TYPE)	ØA	B	C	ØD	ØE	F	G	L1	L2	S	H STROK	KG	MAX ÇALIŞMA BASINCI (BAR)	YAĞ HACMİ (L)
HDC 4x4000xØ75	165	205	325	65	50	105	R $\frac{3}{4}$ "	1150	180	40	4000	190	170	40
HDC 4x4000xØ95	190	235	355	65	50	110	R $\frac{3}{4}$ "	1150	180	40	4000	245	170	57
HDC 4x4500xØ75	165	205	325	65	50	105	R $\frac{3}{4}$ "	1295	180	40	4428	211	170	40
HDC 4x4500xØ95	190	235	355	65	50	110	R $\frac{3}{4}$ "	1295	180	40	4428	250	170	57

Kapalı boy ve strok ölçüleri talebe göre değiştirilebilir.
Length and stroke dimensions are subject to change according to demand closed



5 KADEMELİ ÖNDEN TERAZİ MAFSALLI (TİP C)

Balance articulated at front 5 stages (Type C)

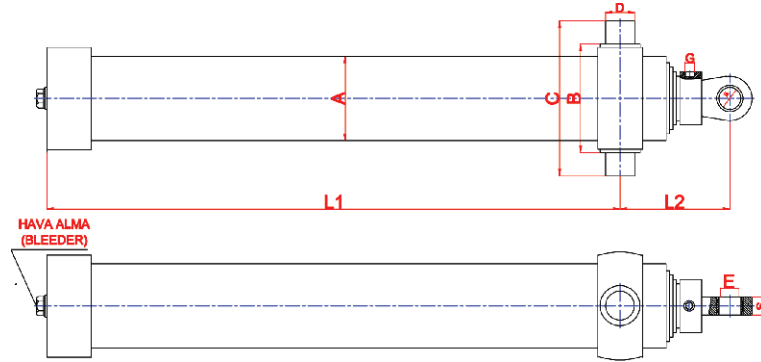

5 KDM Ø75

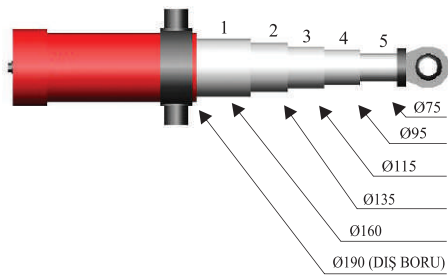

5 KDM Ø95

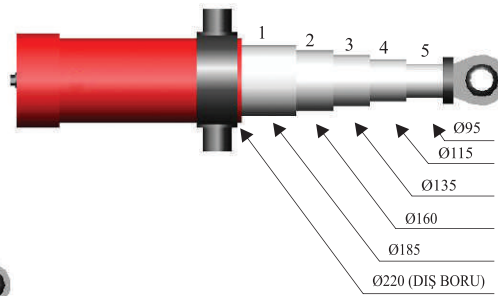

5 KDM Ø115

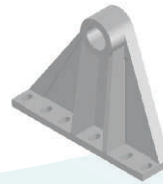
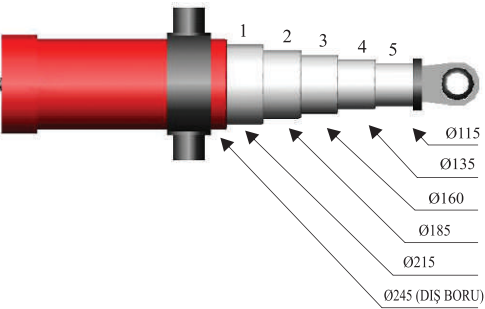

TİP (TYPE)	ØA	B	C	ØD	ØE	F	G	L1	L2	S	H STROK	KG	MAX ÇALIŞMA BASINCI (BAR)	YAĞ HACMİ (Lt)
HDC 5x5700xØ75	190	235	235	65	50	105	R 3/4"	1295	180	40	5535	265	170	76
HDC 5x5700xØ95	220	255	370	65	50	110	R 3/4"	1295	180	40	5512	324	170	103
HDC 5x5700xØ115	245	295	410	68	50	120	R 3/4"	1295	200	40	5489	422	170	160

Kapalı boy ve strok ölçüleri talebe göre değiştirilebilir.

Length and stroke dimensions are subject to change according to demand closed